



The Great British Shower Company 

EVERYDAY SHOWERING



Safeguard+

Touch

T80Z Fast-Fit Thermostatic

T80Z Fast-Fit

T75

T70Z

Elina Mixers

Eden Mixers

Dove Mixers

Nene Mixers

EXE Mixers



www.plumbcenter.co.uk

EVERYDAY SHOWERING

Choose from Triton's recommended everyday showers, designed to suit a range of applications. Triton's electric showers are great for both new and replacement installations while the range of mixer showers offer both easy installation and great performance.

Whichever shower you choose you can be sure that it will be stylish, easy to fit and affordable.

Key

INCLUSIVE SHOWERING



AFFORDABLE STYLE



EASE OF INSTALLATION



VALUE FOR MONEY



Safeguard+

Thermostatic Electric Shower

The Safeguard+ combines design, safety and simplicity to make it a great shower for all.

- Tri-Therm™ regulates the shower temperature to within +/- 1°C
- Large push button start/stop
- Tactile surfaces and audible feedback
- Safe-Set™ tamper proof adjustable max temperature stop and timed shutdown
- Provision for a connection to both manual and digital level access waste pump
- Extended riser rail kit and extra long reinforced hose
- Easy to use rub clean shower head
- 5 spray patterns
- Optional robust grab riser rail can be used as a grab bar with up to 150kg support load
- A hard wired remote control option is also available

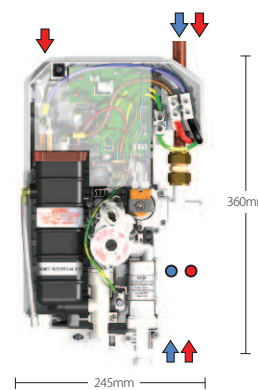

Dimensions given are approximate



Grab riser rails can be used as a grab bar if required



Model

Safeguard+ 8.5kW Electric Shower	D79367
Safeguard+ Grab 8.5kW Electric Shower	D79370
Safeguard+ Grab 8.5kW Electric Shower W Remote	D79371
Safeguard+ 9.5kW Electric Shower	D79368

Code

Touch

Using modern touch screen technology, Touch brings digital to the bathroom.

- Touch Controls
- Swivel-Fit™ - A 180° reversible water inlet providing left and right hand-side water connectivity.
- Illuminated start/stop icon
- Digital temperature read out
- Chrome riser rail with adjustable fixing brackets
- Rub clean shower head - 5 spray patterns

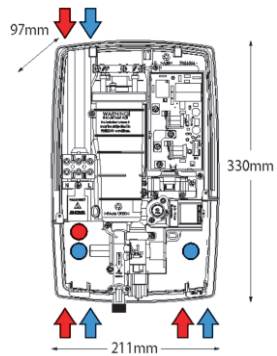

Diagram Key:
 Water Entry Points
 Cable Entry Points

Dimensions given are approximate



Model	Code
Touch White 8.5kW	D79230
Touch White 9.5kW	D79231



Aspirante

With its ultra clean lines and minimalist styling, Aspirante is more than a shower. It's a statement.

- Swivel-Fit™ - A 180° reversible water inlet providing left and right hand-side water connectivity.
- Soft press illuminated power buttons
- Push button start/stop
- Power on indicator
- Low pressure indicator
- Rub clean shower head - 5 spray patterns

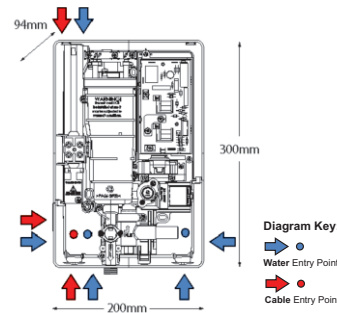

Diagram Key:
 Water Entry Points
 Cable Entry Points

Dimensions given are approximate



Model	Code
Aspirante 8.5kW Gloss Black	D79026
Aspirante 8.5kW Gloss White	D79025
Aspirante 8.5kW Gun Metal	D79030
Aspirante 8.5kW Brushed Steel	D79029
Aspirante 8.5kW Riviera Sand	D79027
Aspirante 9.5kW Gloss Black	D79032
Aspirante 9.5kW Gloss White	D79031
Aspirante 9.5kW Gun Metal	D79036
Aspirante 9.5kW Riviera Sand	D79033
Aspirante 9.5kW Brushed Steel	D79035



Thermostatic T80Z Thermostatic Fast-Fit

With Dura-Flow™ Technology

The shower that combines the benefits of the original T80Z Thermostatic, with the market leading installation benefits of the T80Z Fast-Fit. Plus Triton introduces new Dura-Flow™ technology for showers that last longer. Making the T80Z Thermostatic Fast-Fit ideal for all, whether an installer, specifier or the end-user.

NEW

- 8 water and 6 cable entry points
- Triton's patented Swing-Fit™ terminal block for easy cable connection left or right
- A dual water inlet, designed to be the perfect length left or right, avoids the need for extra fittings
- Additional room to manoeuvre on both sides
- Entry trims that can be removed and refitted without the need to remove the unit or tools
- Only 2 minutes to commission

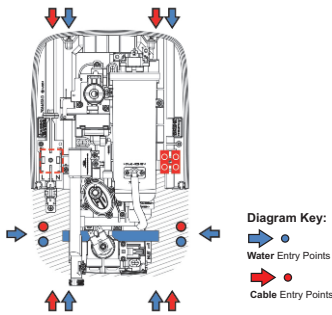

Dimensions given are approximate



Model	Code
T80Z Thermostatic Fast Fit 8.5kW	D00445
T80Z Thermostatic Fast Fit 9.5kW	D00446
T80Z Thermostatic Fast Fit 10.5kW	D00447



T80Z Fast-Fit

The ultimate replacement electric shower.

- Swing-Fit™ terminal block for left or right hand electric connections
- Swivel-Fit™ water inlet for left or right hand water connections
- Generous footprint for covering existing tile marks
- Adjustable top bracket riser rail to cover previous fixing holes
- Available in 7.5kW, 8.5kW, 9.5kW and 10.5kW

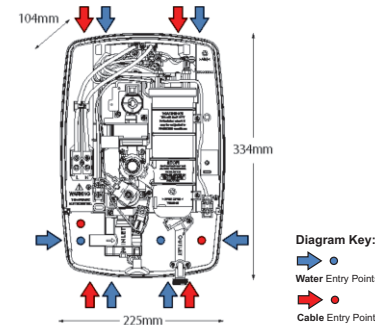

Dimensions given are approximate



Model	Code
T80Z Fast-Fit 7.5kW White/Chrome	D00464
T80Z Fast-Fit 8.5kW White/Chrome	D00465
T80Z Fast-Fit 8.5kW Chrome	D00469
T80Z Fast-Fit 9.5kW White/Chrome	D00466
T80Z Fast-Fit 9.5kW Chrome	D00470
T80Z Fast-Fit 10.5kW White/Chrome	D00467
T80Z Fast-Fit 10.5kW Chrome	D00471



T75 Electric Shower

- Dual water inlet port to accommodate left and right hand water entry
- Large temperature control
- Start/stop button
- Power on indicator
- Rub clean shower head - single spray pattern

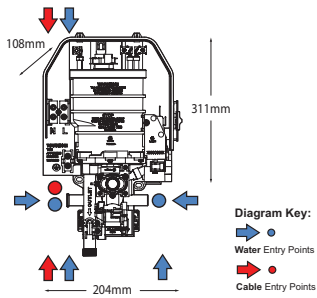

Dimensions given are approximate

Model	Code
T75 8.5kW White	D79237
T75 9.5kW White	D79238



T70Z Electric Shower

- Swivel-Fit™ - 180° reversible water inlet providing left and right hand-side water connectivity.
- Single control for start/stop selection and power selection
- Separate temperature and power controls
- Rub clean shower head - 3 spray patterns

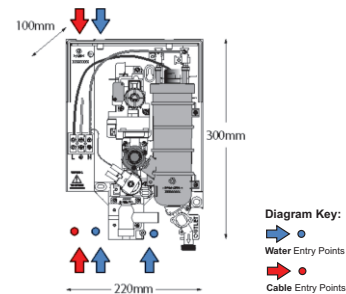

Dimensions given are approximate



Model	Code
T70Z 7.5kW Electric Shower White/Chrome	D78066
T70Z 8.5kW Electric Shower White/Chrome	D78065

Elina TMV3 Inclusive Bar Mixer Shower with Grab Kit

An inclusively designed, TMV3 approved thermostatic bar mixer shower with grab riser rail kit and easy to grip and control, low resistance lever controls with clear flow and temperature markings. Suitable for use with all systems including gravity fed, unvented and combination boilers. Includes a full 3 year parts and labour guarantee.

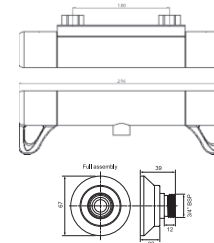

- Suitable for all ages and abilities
- TMV3 approved
- Maintains temperature setting closely & consistently
- Lever controls - low resistance & forward facing
- No dirt traps - easy to clean hygienic design
- Now with wall surface fixing brackets
- Dual purpose grab riser rail option - withstands up to 150kg support load
- Easy clean Showerhead 110mm diameter
- 5 spray patterns
- Rub clean nozzles & removable spray plate
- 2000mm hose ideal for both users and carers
- A 940mm polish stainless steel grab riser rail able to withstand up to 150kg support load.
- Grab Riser Rail is tested to BS EN 12182

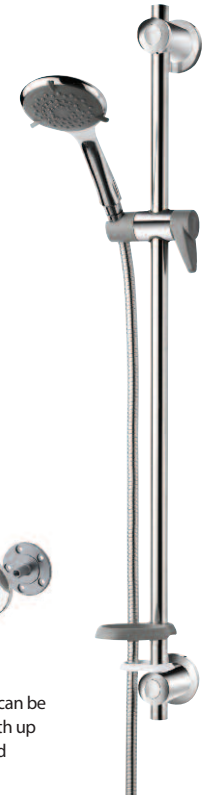

Model	Code
Elina Inclusive TMV3 Bar Mixer & Grab Riser Kit	D72429

Elina TMV3 Concentric with Grab Kit

An inclusively designed, TMV3 approved thermostatic concentric mixer shower. Available as exposed or built-in option. Comes with grab riser rail kit and easy to grip and control, low resistance lever handles which are forward facing for easy access. Includes clear flow and temperature markings. Suitable for use with all systems including gravity fed, unvented and combination boilers. Includes a full 3 year parts and labour guarantee.

Ideal for use in care homes, hospitals and nursing homes.



- Separate flow and temperature controls
- Tamper proof lever controls
- Factory set maximum temperature at 38°C
- Automatic shutdown if hot and cold supplies fail
- Extended grab riser rail kit
- Easy to use rub clean shower head - 5 spray patterns
- Dual purpose grab riser rail option - withstands up to 150kg support load
- Easy clean Showerhead 110mm diameter

- 5 spray patterns
- Rub clean nozzles & removable spray plate
- 2000mm hose ideal for both users and carers
- A 940mm polish stainless steel grab riser rail able to withstand up to 150kg support load.
- Grab Riser Rail is tested to BS EN 12182

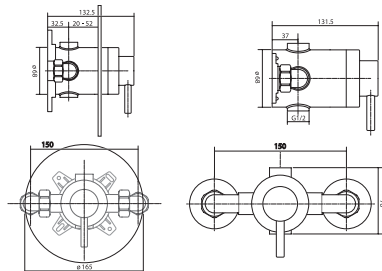

Model	Code
Elina TMV3 Built In Concentric with Grab Kit	D74638
Elina TMV3 Exposed Concentric with Grab Kit	D74634

Eden Mixer

The Eden concentric mixer shower range is ideally suited for family use with its easy to turn controls, five spray pattern shower head and high quality finish. TMV2 and WRAS approval provides total peace of mind and makes Eden ideal for new build opportunities.

Available as an Exposed or Built-in Mixer together in a one box solution with over three options so the choice is yours!

Eden Concentric Mixer - Exposed

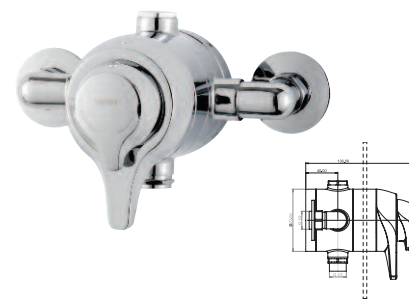

Eden Concentric Mixer - Built-in



Model	Code
Eden Eco Concentric Mixer	D72426
Eden Concentric Mixer	D72425
Eden Extended Concentric Mixer	D72427

Standard Mixer

- Suitable for all water systems including gravity fed
- Accessible forward facing controls
- Comes with chrome kits, 1.25m hose and 5 mode showerhead
- Surface mounting plate for easy install
- Compression fit onto 15mm pipe tails
- Optional 12 l/min flow limiter easily fitted in outlet



Eco Mixer

As the standard mixer but also featuring:

- 6 l/min official water efficiency rating
- Factory fitted flow limiter
- Assists compliance with Building Regulations Part G water usage requirements

Extended Mixer

As the standard mixer but also featuring:

- Extended 940mm riser rail offering a wide range of height adjustment
- Extended 2m hose offers additional reach
- Supplementary lower level handset holder included
- Ideal for families with small children and shower chair users

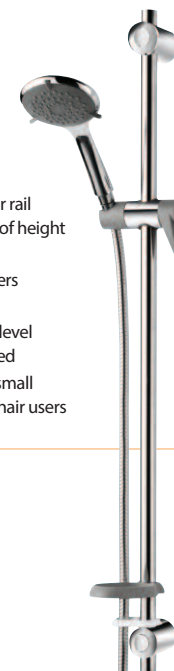

Dove Bar Diverter

- Thermostatic temperature control
- Suitable for high pressure systems only
- 150mm pipe centres
- Separate flow and temperature controls
- Adjustable maximum temperature stop
- Diverter control to switch water between showerheads

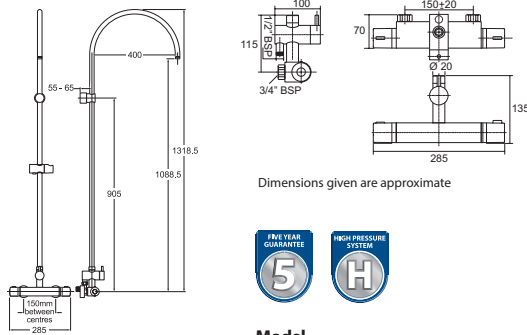

Dimensions given are approximate



Model
Dove Bar Mixer C/W Dvtr Unichrome



Includes wall surface fixing brackets

Code
D76971

Dove Bar Mixer

- Thermostatic temperature control
- Separate flow and temperature controls
- Dog leg fixings - 130-170mm pipe inlets
- Maximum temperature stop to avoid accidentally turning the temperature too high



Model
Dove Thermostatic Bar Mixer & Kit

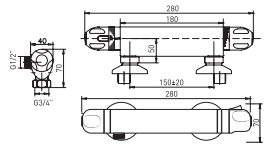

Dimensions given are approximate

Code
D76467



Includes wall surface fixing brackets

Dove Mini Concentric Mixer

- Thermostatic temperature control
- Suitable for high pressure systems only
- 150mm pipe centres
- Separate flow and temperature controls
- Adjustable maximum temperature stop
- Diverter control to switch water between showerheads



Model
Dove Thermo Mini Conc Valve & Kit

Code
D72435

Dove Sequential Mixer

- Thermostatic mixer shower
- Suitable for high and low pressure systems
- 150mm pipe centres
- Single control for temperature adjustment with constant flow



Model
Dove Thermostatic Seq Mixer & Kit

Code
D72436

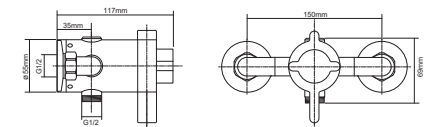

Dimensions given are approximate

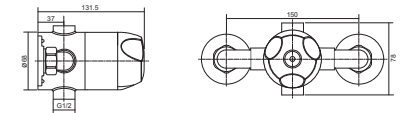

Dimensions given are approximate



Nene Cool Touch Bar Mixer

- Cool Touch feature ensures that the metal valve body does not get warm to the touch, unlike conventional bar mixer showers
- Automatic shutdown if hot or cold supply fails
- Separate flow and temperature controls
- Rub clean shower head - 3 spray patterns

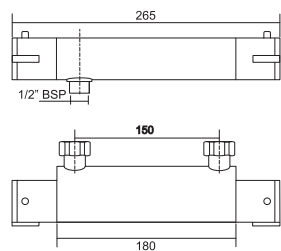
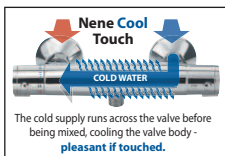

Dimensions given are approximate



Model
Nene Cool Touch Bar Mixer with brackets

Code
D72334



Includes wall surface fixing brackets

EXE Bar Mixer

One great product - two different handle solutions

Standard handle



- Automatic shutdown if hot or cold supplies fail
- Separate flow and temperature controls
- Adjustable maximum temperature stop
- 1 piece, 1 screw rail fixing with adjustable centres
- Rub clean shower head - 3 spray patterns

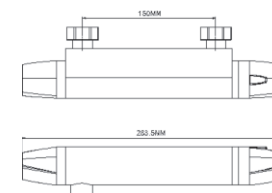

Dimensions given are approximate

Easy to use Lever handle option



Model
Exe Bar Mixer
Exe Lever Bar Mixer

Code
D74631
D74632

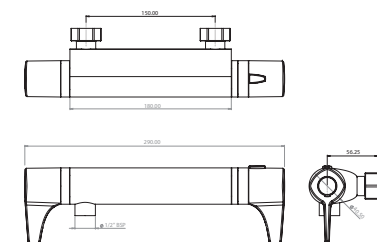

Dimensions given are approximate



The Great British Shower Company 

Recommended Electric & Mixer showers

Order Codes:

Electric Showers

Safeguard+ 8.5kW Electric Shower	D79367
Safeguard+ Grab 8.5kW Electric Shower	D79370
Safeguard+ Grab 8.5kW Electric Shower W Remote	D79371
Safeguard+ 9.5kW Electric Shower	D79368
Touch White 8.5kW	D79230
Touch White 9.5kW	D79231
Aspirante 8.5kW Gloss Black	D79026
Aspirante 8.5kW Gloss White	D79025
Aspirante 8.5kW Gun Metal	D79030
Aspirante 8.5kW Brushed Steel	D79029
Aspirante 8.5kW Riviera Sand	D79027
Aspirante 9.5kW Gloss Black	D79032
Aspirante 9.5kW Gloss White	D79031
Aspirante 9.5kW Gun Metal	D79036
Aspirante 9.5kW Riviera Sand	D79033
Aspirante 9.5kW Brushed Steel	D79035
T80Z Thermostatic Fast Fit 8.5kW	D00445
T80Z Thermostatic Fast Fit 9.5kW	D00446
T80Z Thermostatic Fast Fit 10.5kW	D00447
T80Z Fast-Fit 7.5kW White/Chrome	D00464
T80Z Fast-Fit 8.5kW White/Chrome	D00465
T80Z Fast-Fit 8.5kW Chrome	D00469
T80Z Fast-Fit 9.5kW White/Chrome	D00466
T80Z Fast-Fit 9.5kW Chrome	D00470
T80Z Fast-Fit 10.5kW White/Chrome	D00467
T80Z Fast-Fit 10.5kW Chrome	D00471
T75 8.5kW White	D79237
T75 9.5kW White	D79238
T70Z 7.5kW Electric Shower White/Chrome	D78066
T70Z 8.5kW Electric Shower White/Chrome	D78065

Mixer Showers

Elina Inclusive Tmv3 Bar Mixer & Grab Riser Kit	D72429
Elina TMV3 Built In Concentric with Grab Kit	D74638
Elina TMV3 Exposed Concentric with Grab Kit	D74634
Eden Eco Concentric Mixer	D72426
Eden Concentric Mixer	D72425
Eden Extended Concentric Mixer	D72427
Dove Thermostatic Bar Mixer & Kit	D76467
Dove Thermostatic Seq Mixer & Kit	D72436
Nene Cool Touch Bar Mixer with brackets	D72334
Exe Bar Mixer	D74631
Exe Lever Bar Mixer	D74632



Scan this code for more information on inclusive showering



Contact us

Installer Hotline: 02476 378 344

Email: technical@tritonshowers.co.uk

Customer Services: 02476 372 222

Website: www.tritonshowers.co.uk



Triton is a division of Norcros Group (Holdings) Limited.

Triton Showers, Triton Road, Nuneaton, Warwickshire, CV11 4NR

It is our policy to improve the design and specification of our products and we reserve the right to depart from the details given without prior notice.